

I-PRO 2 BOWLS, WITH MECHANICAL CONTROL - R290



Ref: 561558 (IPRO2M)

Slushie machine, with 2x11-litres lighted and insulated bowls I-Tank, mechanical control, refrigerant gas R290

I-PRO 2 MECHANICAL is a professional slush machine with n. 2 I-Tank insulated bowls, 11 litres each, and mechanical control.

Every detail has been studied to create a unique equipment thanks to the numerous patents and innovations available for this model.

This equipment has the I-Tank insulated tank as standard. The shape of the tanks, which work independently, guarantees a natural mixing effect for an optimal consistency of the product.

The look of this equipment is modern and eye-catching, thanks to the LED-light system that illuminates the product inside the tank.

The equipment can dispense: slushies, milkshakes, cold drinks and frozen cocktails.

I-PRO is an ideal slush machine for bars, amusement parks, fast food chains, kiosks, restaurants, water parks and much more.

I-PRO 2 BOWLS, WITH MECHANICAL CONTROL - R290

Specifications

- It is possible to customize the graphics on the front, on the lid and on the back (subject to negotiation).
- The special shape of the I-PRO tanks, 11 litres of finished product each and LED-lighted, allows for a natural mixing effect which guarantees perfect consistency of the product.
- Tanks work independently, this allows you to produce with a single equipment: slushies, milkshakes, frozen drinks and cold drinks.
- I-PRO is an ideal slush machine for bars, amusement parks, motorway restaurants, fast food chains, kiosks, restaurants, water parks and much more.
- Optionals available: autofill lid (pre-mix or post-mix) for the automatic filling of the tanks, and the LED-backlighted front panel.

Construction

- Slush machine with 2x11-litres insulated bowls
- The patented I-Tank insulated bowl reduces the impact of ambient temperature on the product, improving its cooling efficiency and guaranteeing energy and cost savings.
- The mechanical control allows you to manually set the “production mode” and the “night mode”.

I-PRO 2 BOWLS, WITH MECHANICAL CONTROL - R290

Electric

Supply voltage:	220-240 V / 1 ph / 50 Hz
Electrical power max.:	0.78 kW
Current consumption:	4.2 Amps
Plug type:	CE-SCHUKO

Key Information:

Number of bowls:	2
Bowl's capacity:	ISO 9001; ISO 14001 lt
Control board:	Mechanical
Dimensions, Width:	400 mm
Dimensions, Depth:	580 mm
Dimensions, Height:	870 mm
Net weight:	60 kg
Cooling system:	AIR

Refrigeration Data

Refrigerant gas:	R290
------------------	------



The company reserves the right to make modifications to the products without prior notice. All information correct at time of printing.

2025.04.11

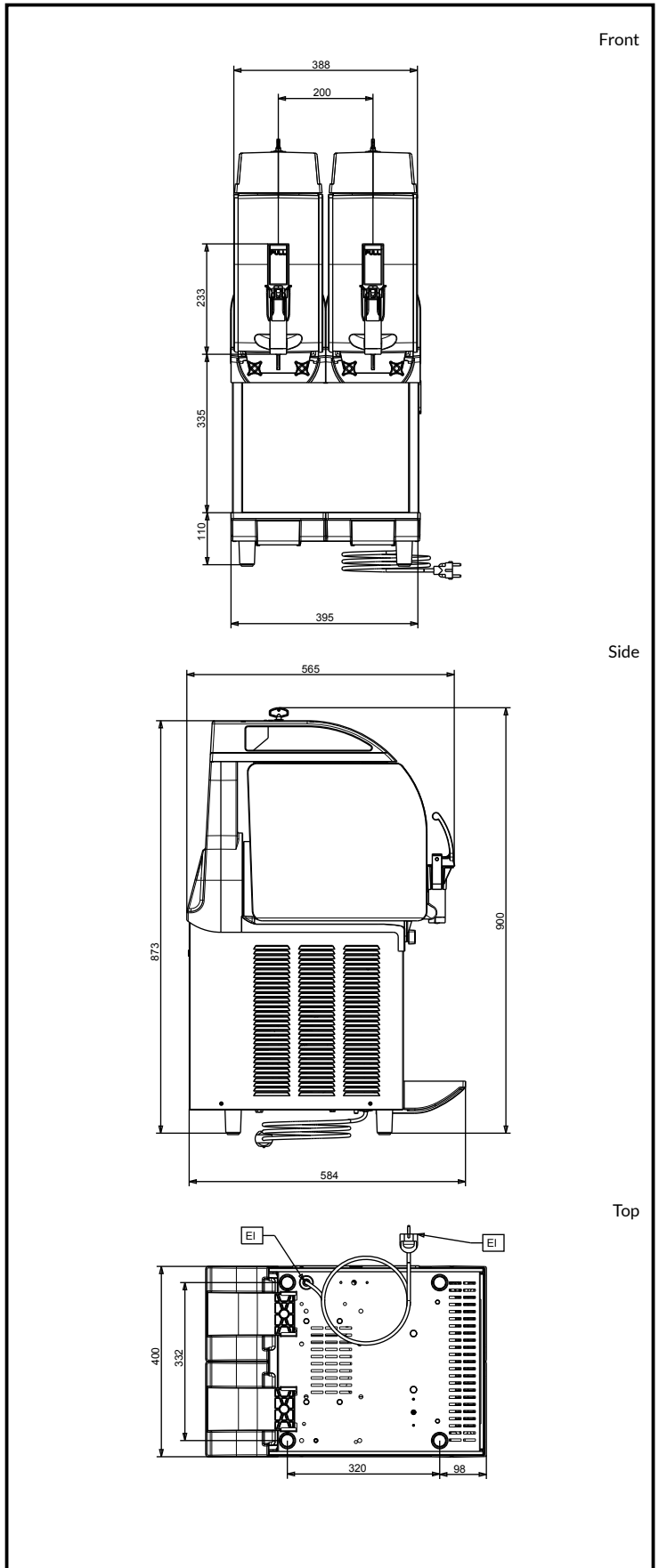

SPM

www.spm.drink-systems.com
infospm@electroluxprofessional.com